

cnPilot™ e505, e510, e700 Outdoor Wi-Fi Access Points

802.11ac Wave 2 Internal Antenna Outdoor Wi-Fi Access Points

QUICK LOOK:

Ideal for outdoor communities, public Wi-Fi or enterprise Wi-Fi, these omni-directional access points are tailored to low-, medium- and high- density applications. Each is designed with an integrated mounting bracket & internal antennas to make installation a snap and repeatable from one site to the next.

e505	e510	e700
802.11 a/b/g/n/ac Wave 2		
Omni-directional antenna coverage		
IP67 rated housing, UV protection		
5 GHz (2x2), 2.4 GHz (2x2)		5 GHz (4x4), 2.4 GHz (2x2)
-30°C to 60°C	-40°C to 65°C	-40°C to 60°C
Small size hides easily	Shock & Vibration rail certified	15W power out on GE2



CLOUD-MANAGED ACCESS

All cnPilot access points are managed by cnMaestro from the cloud, an on-premises VM or a private datacenter. cnMaestro provides a single-pane-of-glass dashboard for Wi-Fi, Ethernet, fixed wireless broadband and service provider home routers.

- Zero-touch onboarding
- Inventory reports, mass configuration and upgrade
- Dashboard views with alarms and key performance metrics
- Remote troubleshooting tools
- Hierarchical device organization
- Cloud-managed guest portal with social login, vouchers, rate, time and throughput limits

cnMaestro Essential cloud management is included at no additional cost. There are no setup fees, license, or recurring costs. cnMaestro includes detailed network statistics, channel utilization graphs, and integrated remote troubleshooting tools to ensure service is always on.

FLEXIBLE DESIGN FOR OUTDOOR ENTERPRISE WI-FI

The e505 is designed for fast, discrete deployment of outdoor Wi-Fi, ideal for an aesthetically sensitive area like a hotel pool, or unobtrusive public and community Wi-Fi. The e505 has an omni coverage internal antenna with an integrated mounting bracket.

The e510 is rail shock and vibration certified, and includes extended surge and ESD protection. Additionally, an integrated LTE filter reduces impact from nearby LTE frequencies. Operating temperature spans -40°C to 65°C for a wide range of applications.

The e700 provides edge intelligent services and the 4x4 MU-MIMO antenna array to deliver those services. The dual-gigabit Ethernet ports support link aggregation (LAG) for higher throughput needs, or GE2 can be enabled to deliver 15 W of operating power for a Cambium subscriber module or any Ethernet- and PoE-powered device.

cnPilot™ e505, e510, e700 Outdoor Access Points

Access Point Specifications

	e505	e510	e700
US-FCC	Ch 1–11, 36–64, 100–140, 149–165	Ch 1–11, 36–64, 100–140, 149–165	Ch 1–11, 36–64, 100–140, 149–165
ISED Canada	Ch 1–11, 36–64, 100–116, 149–165	Ch 1–11, 36–64, 100–116, 149–165	Ch 1–11, 36–64, 100–116, 149–165
EU-ETSI	Ch 1–13, 36–64, 100–140	Ch 1–13, 36–64, 100–140	Ch 1–13, 36–64, 100–140
ROW	Ch 1–13, 36–64, 100–144, 149–173 <i>individual country limits apply</i>	Ch 1–13, 36–64, 100–144, 149–173 <i>individual country limits apply</i>	Ch 1–13, 36–64, 100–144, 149–173 <i>individual country limits apply</i>
Radios	1 x 5 GHz radio (802.11 a/n/ac Wave 2), 2x2 1 x 2.4 GHz (802.11 b/g/n), 2x2 SU-MIMO / MU-MIMO: 2 streams		
Wi-Fi	802.11 a/b/g/n/ac	802.11 a/b/g/n/ac	802.11 a/b/g/n/ac
SSID Security	WPA2 (802.11i), WPA2 Enterprise (802.1x/EAP), WPA PSK, Open		
Max PHY Rate	2.4 GHz radio: 300 Mbps 5 GHz radio: 867 Mbps	2.4 GHz radio: 400 Mbps 5 GHz radio: 867 Mbps	2.4 GHz radio: 400 Mbps 5 GHz radio: 1733 Mbps
Ethernet	1 IEEE Gigabit, auto sensing	1 IEEE Gigabit, auto sensing	2 IEEE Gigabit, auto sensing 1 port with Cambium 30V or 48V PoE Out
Antenna	Internal omni-directional 2.4 GHz: 5 dBi 5 GHz: 5 dBi	Internal omni-directional 2.4 GHz: 8 dBi 5 GHz: 9 dB	Internal omni-directional 2.4 GHz: 8 dBi 5 GHz: 8 dBi
Max EIRP	2.4 GHz: 26 dBm 5 GHz: 26 dBm	2.4 GHz: 32 dBm 5 GHz: 34.5 dBm	2.4 GHz: 33 dBm 5 GHz: 36 dBm
	(EIRP limited by country regulations)		
WLAN	100 clients, 32 SSIDs (16 per radio) WPA-TKIP, WPA2 AES, 802.1x, 802.11w PMF	256 clients, 32 SSIDs (16 per radio) WPA-TKIP, WPA2 AES, 802.1x, 802.11w PMF	512 clients, 32 SSIDs (16 per radio) WPA-TKIP, WPA2 AES, 802.1x, 802.11w PMF
Power	802.3af or 802.3at powered device Typical load: 8W, Max: 12W	802.3af or 802.3at powered device Typical load: 10W, Max: 12.95W	802.3at powered device Or 60 W Injector for max load with power-out Typical load: 18W, Max: 25W 40W when connected to full 802.3af load on GE 2 Canopy power out or 802.3af
Mounting	Integrated pole, wall mount	Integrated pole, wall mount	Integrated pole 38 mm and 76 mm (1.5 in and 2.99 in) , wall mount

cnPilot™ e505, e510, e700 Outdoor Access Points

Access Point Specifications cont'd

	e505	e510	e700
Dimensions	227 mm x 130 mm x 70 mm (8.94 in x 5.12 in x 2.76 in)	290 mm x 208 mm x 78 mm (11.32 in x 8.19 in x 3.07 in)	315 mm x 215 mm x 66 mm (12.4 in x 8.46 in x 2.6 in)
Weight	800 g (1.76 lbs)	1,100 g (2.43 lbs)	1,700g (3.75 lbs)
LED	Single Tri-color LED (amber, blue, green)	Single Tri-color LED (amber, blue, green)	Two single color status LED
Physical Lock	Kensington slot	Kensington slot	Kensington Key Slot
Ambient op temp	-30°C to 60°C	-40°C to 65°C	-40°C to 65°C
Storage temperature	-40°C to 70°C	-40°C to 70°C	-40°C to 70°C
Humidity	95% RH non-condensing	95% RH non-condensing	95% RH non-condensing
Wind Resistance	–	224 kph (139 mph)	–
LTE Band filter	–	38, 40	38, 40
MTBF	116k hours	420k hours	700k hours
Overvoltage Protection	–	–	Category 1
Certifications	802.11u, Hotspot 2.0 FCC, ETSI, CE, EN 60601-1-2, IEC60950 UL2043	Wi-Fi Alliance 80211a/b/g/n/ac, Passpoint 2.0 FCC, ETSI, CE, EN 60601-1-2, IEC60950 UL2043	Wi-Fi Alliance 802.11a/b/g/n/ac, Passpoint 2.0 FCC, ETSI, CE, EN 60601-1-2, IEC60950 UL2043

cnPilot™ e505, e510, e700 Outdoor Access Points

Management

Adaptive cnPilot Network

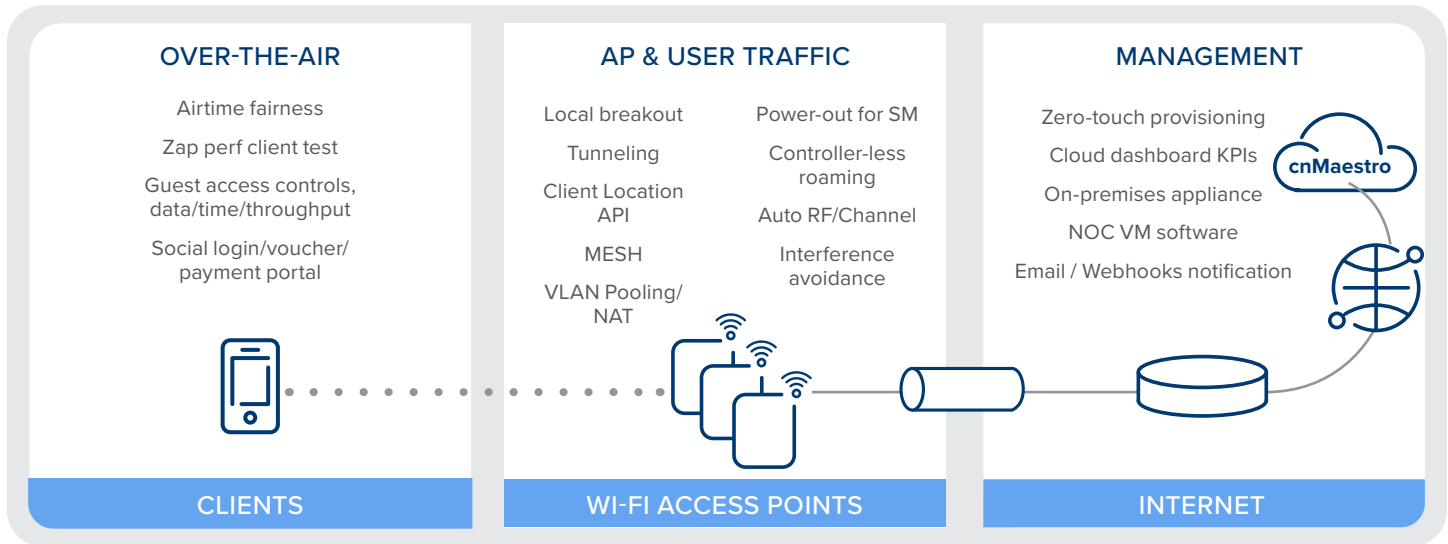

Cambium Networks cnMaestro uses a distributed intelligence architecture with a cloud-first cnMaestro management and edge-intelligent AP's that self-optimize for the RF environment. cnMaestro and cnPilot AP's provide automatic RF management and seamless roaming, with a cloud-first, multi-site management for up to 10,000 devices and hundreds of thousands of connected clients. cnMaestro delivers single-pane-of-glass management for Cambium Networks broadband fixed wireless, cnMatrix Ethernet switches, enterprise-grade Wi-Fi AP's and service provider residential routers.

Interfaces HTTP / HTTPS web interface, SSH, Telnet
SNMP V1, V2, V3
Syslog, SNMP traps, NTP

Deployment Monetized guest portal with design tools

Services Monetized, cloud managed guest portal with design tools

Captive Portal **Portal features hosted on cnMaestro:**
Design templates, customization tools
supports 3rd party external portal
RADIUS/LDAP/Click Through authentication
Active Directory, Google, Facebook, Office 365, OAuth 2.0
Data Rate/Throughput limits, Time duration

Portal features hosted on the AP:
supports 3rd party external portal
RADIUS/LDAP/Click Through authentication
Data Rate/Throughput limits, Time duration

Hotspot 2.0 Hotspot 2.0 / Passpoint 2.0

Accounting RADIUS accounting, load balancing AAA servers, Dynamic Authorization COA, DM

Service Availability Critical network resource monitor with SSID shutdown

cnPilot™ e505, e510, e700 Outdoor Access Points

Network Specifications

Authentication Encryption 802.1x EAP-SIM/AKA/AKA'/FAST, EAP-PEAP, EAP-TTLS, EAP-TLS/MSCHAPv2, PEAPv0/PEAPv1
 MAC authentication to local database (on AP, on Controller) or external RADIUS.
 MAC auth fallback to guest portal

Scheduled WLAN On/off by day, week, time of day

APIs RESTful management and statistics API
 Presence location API
 Splunk WebSocket integration, WebSocket
 DNS, NAT, TCP connection log

QoS 802.11e/WMM QoS. DSCP/ToS mapping

VLAN 802.11Q, max 4096

Fast Roaming 802.11r, OKC, cnMaestro assisted roam

Sticky Client Enhanced roaming with thresholds

Mesh Multi-hop (2), either band

Channel Selection Auto RF: Manual, or automatic

Network NAT, NAT logging firewall, DOS protection, L2/L3/DNS ACL, DHCP server, DHCP Relay option 82
 LLDP, IGMP v1, v2
 VLAN Pooling, RADIUS attribute VID
 VLAN per SSID, per user
 Integrated WIDS (wireless intrusion detection)

Band Steer Load Balance Yes

Tunnel L2TPv2, L2GRE, PPPoE

Network and RF Management Tools Out-of-band RF spectrum analysis, radio self test network assurance, RF monitor with channel/noise/interference, wired and wireless remote packet capture, ZapD performance tool, rogue, AP detection

Standards

Wi-Fi Protocols VHT MCS rates, 256-QAM, HT20/40/80 MHz

Transmit beamsteering, Airtime Fairness, Packet Aggregation (AMSDU, AMPDU) RIFS, STBC, LDPC, 802.11k, 802.11v, 802.11i

MIMO Power Save, MRC, BPSK, QPSK, CCK, DSSS, OFDM. IEEE 802.11d/e/h/i/k/r/u/v

cnPilot™ e505, e510, e700 Outdoor Access Points

Antenna Patterns - e505

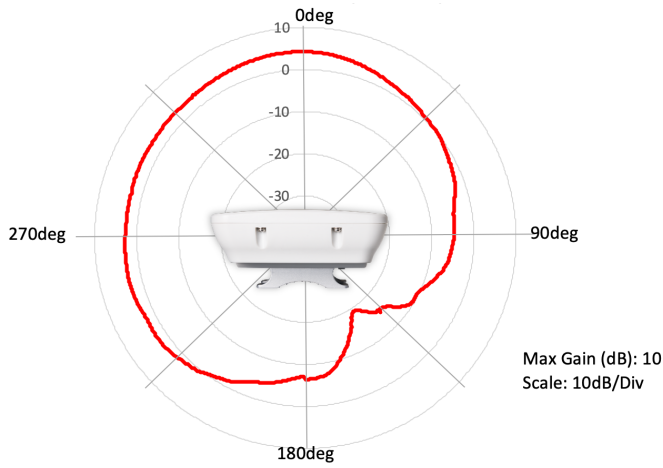

2.4 GHz Azimuth

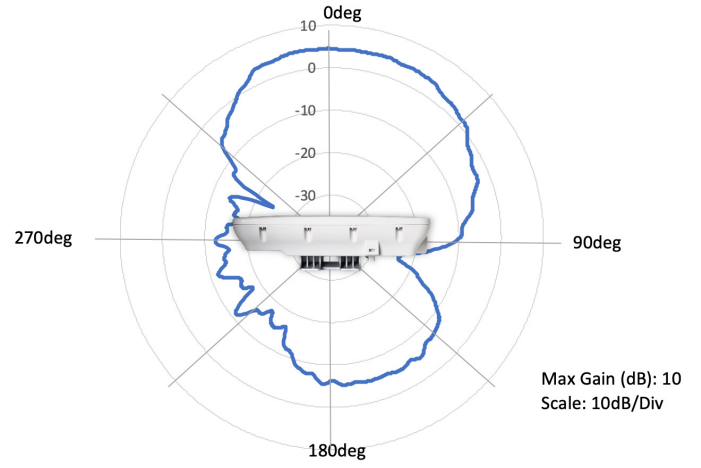

2.4 GHz Elevation

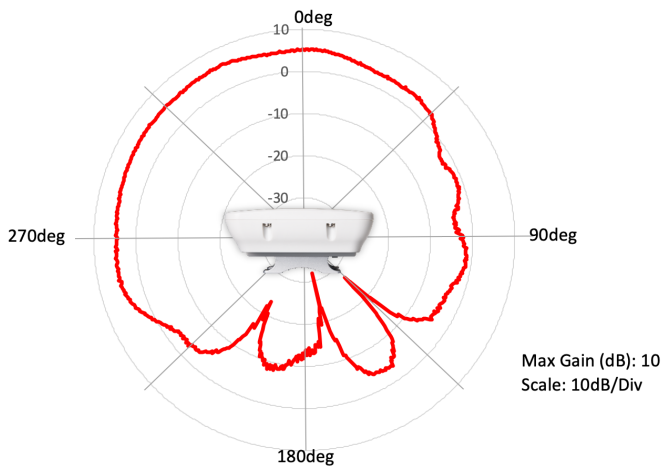

5 GHz Azimuth

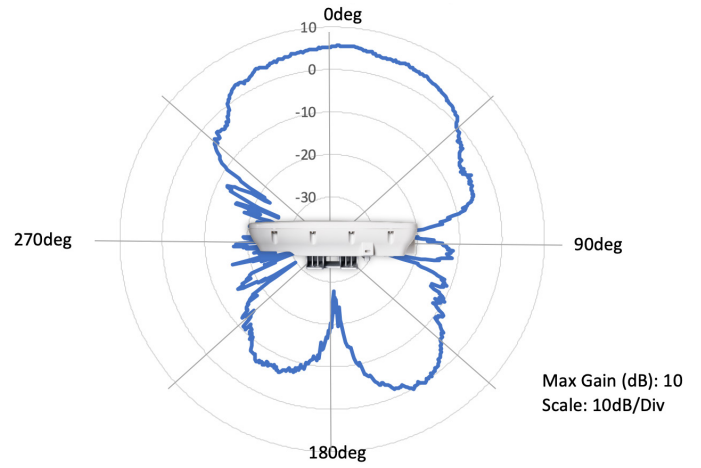

5 GHz Elevation

cnPilot™ e505, e510, e700 Outdoor Access Points

Antenna Patterns - e510

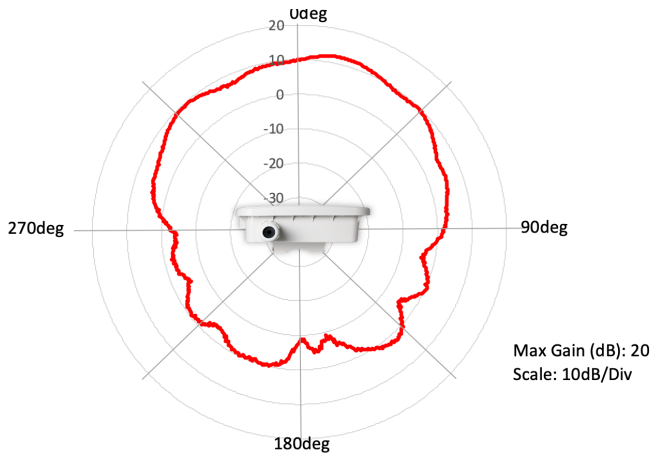

2.4 GHz Azimuth

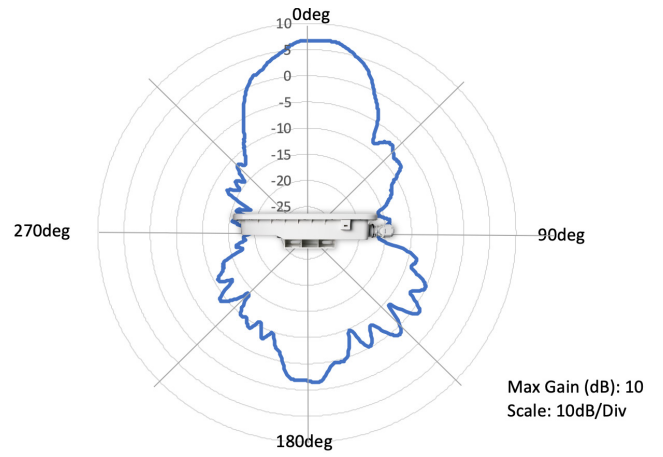

2.4 GHz Elevation

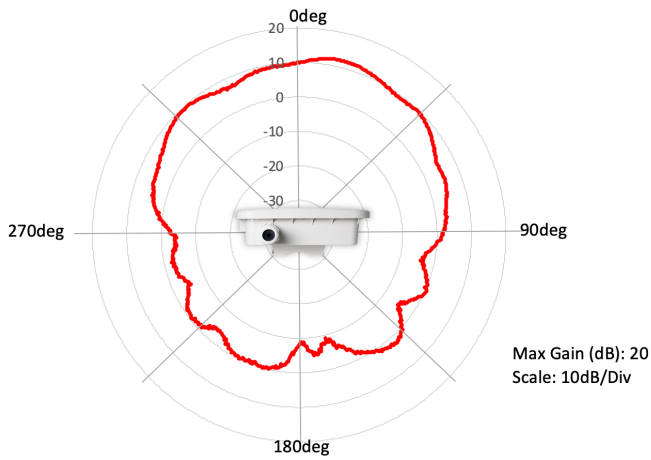

5 GHz Azimuth

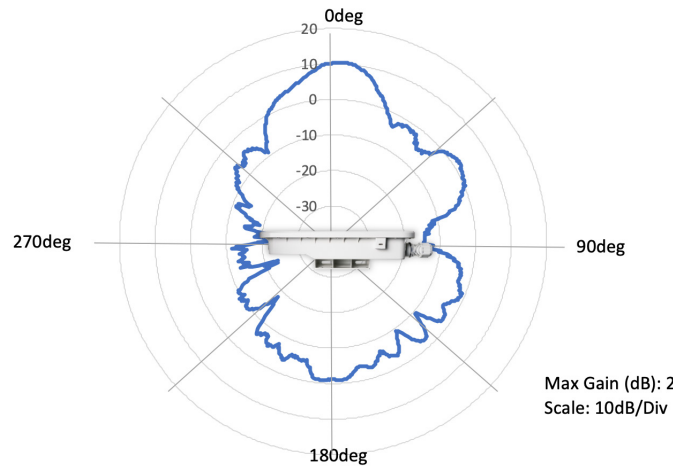

5 GHz Elevation

cnPilot™ e505, e510, e700 Outdoor Access Points

Antenna Patterns - e700

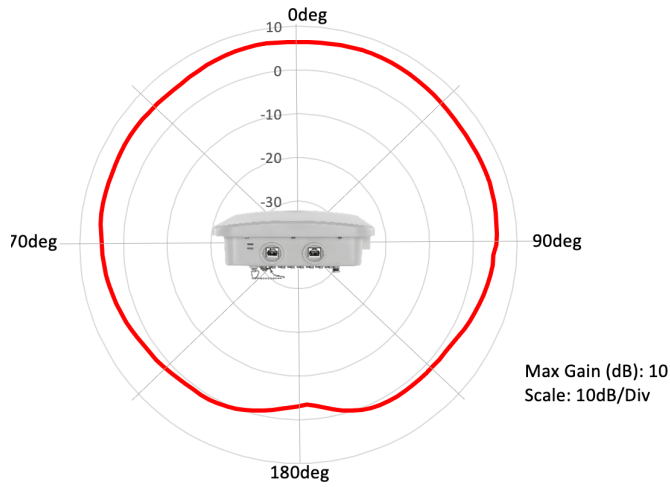

2.4 GHz Azimuth

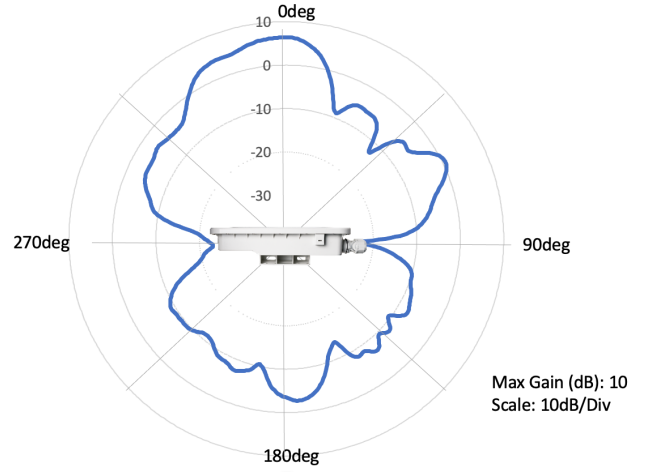

2.4 GHz Elevation

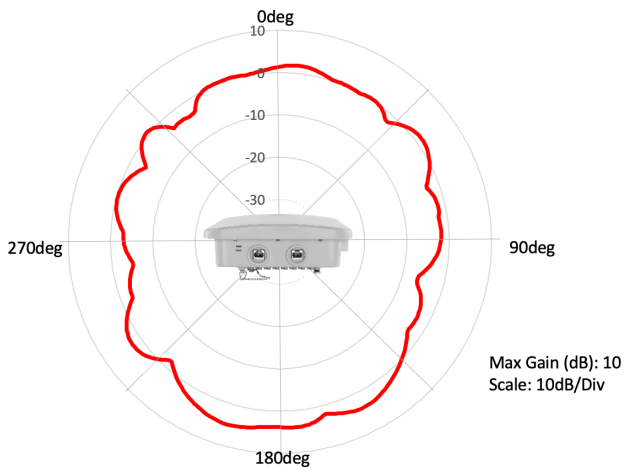

5 GHz Azimuth

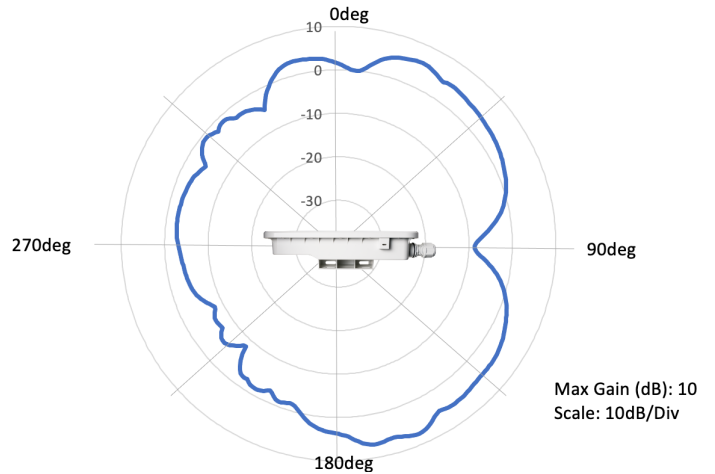

5 GHz Elevation

cnPilot™ e505, e510, e700 Outdoor Access Points

e505



Front



Back



Side



Bottom

e510



Front



Back



Side



Bottom

e700



Front

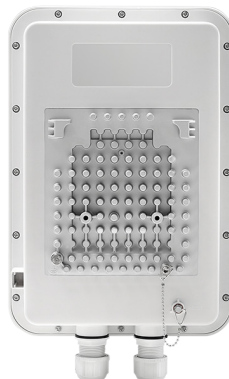

Back



Bottom

cnPilot™ e505, e510, e700 Outdoor Access Points

e505 Ordering Information

PL-E505X00A-US	e505 Outdoor (FCC) 802.11ac Wave 2, 2x2, 5 dBi Omni AP, IP55
PL-E505X00A-EU	e505 Outdoor (EU) 802.11ac Wave 2, 2x2, 5 dBi Omni AP, IP55
PL-E505X00A-RW	e505 Outdoor (ROW) 802.11ac Wave 2, 2x2, 5 dBi Omni AP, IP55
N000000L034A	Power supply, 30W, 56W, RJ45 – Gbps support. C5 AC port. AC line cord sold separately

e510 Ordering Information

PL-E510X00A-US	e510 Outdoor (FCC) 802.11ac Wave 2, 2x2, 8 dBi, WLAN AP
PL-E510X00A-EU	e510 Outdoor (EU) 802.11ac Wave 2, 2x2, 8 dBi, WLAN AP
PL-E510X00A-RW	e510 Outdoor (ROW) 802.11ac Wave 2, 2x2, 8 dBi, WLAN AP
AX-E510RBKT-WW	Shock Mount for e510

e700 Ordering Information

PL-E700X00A-US	e700 Outdoor (FCC) 802.11ac Wave 2, 2x2/4x4, AP
PL-E700X00A-EU	e700 Outdoor (EU) 802.11ac Wave 2, 2x2/4x4, AP
PL-E700X00A-RW	e700 Outdoor (ROW) 802.11ac Wave 2, 2x2/4x4, AP

Not all SKUs are available at first release. Consult your Cambium Networks distributor for country availability.

LIMITED WARRANTY

Cambium Networks cnPilot e505, e510, e700 are covered by an extended hardware warranty for a period of 3 years after point of sale.

ABOUT CAMBIUM NETWORKS

Cambium Networks empowers millions of people with wireless connectivity worldwide. Its wireless portfolio is used by commercial and government network operators as well as broadband service providers to connect people, places and things. With a single network architecture spanning fixed wireless and Wi-Fi, Cambium Networks enables operators to achieve maximum performance with minimal spectrum. End-to-end cloud management transforms networks into dynamic environments that evolve to meet changing needs with minimal physical human intervention. Cambium Networks empowers a growing ecosystem of partners who design and deliver gigabit wireless solutions that just work.

cambiumnetworks.com

11292021